

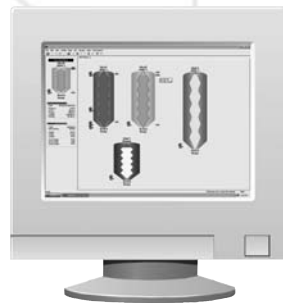

"Setting The Standard For Supplier Excellence"

SiloPatrol[®] **Inventory Management System**

- ▼ Extreme Conditions – No Problem
- ▼ Leader in Cable-Based Smart Sensor Systems and Value
- ▼ Unprecedented and Unsurpassed Sensor Durability & Application Reliability
- ▼ Patent Pending Technology Enhances Application Reliability
- ▼ Unique Network Capable PC-Based Inventory Management Software
- ▼ Affordable Wireless Sensor Interface Available
- ▼ Unmatched RMI/VMI Solutions





- ▼ Second Edition Sensor Uses Hall Effect Technology (Patent Pending) To Maximize Application Reliability
- ▼ Industry-Best Measurement Resolution Of 1/100' (0.12"; 3mm)
- ▼ Second Edition Sensor Is Virtually Maintenance-Free
- ▼ Split-Compartment Enclosure Isolates Electronics And Measurement Optics From Process Material
- ▼ Process Seal Relocated For Fast, Easy Replacement
- ▼ PC-Based Inventory Solutions Or Simple HMI Keypad/Display
- ▼ Pulse And Analog Output Available
- ▼ Hazardous Location Sensor Version
- ▼ Wireless Sensor Interface Solutions
- ▼ Auxiliary System Outputs Available





SiloPatrol®



Remote and local monitoring of plastic storage at four facilities.



SiloPatrol® Inventory Management System

The **SiloPatrol**®  Inventory Management System is the second edition of the industry-leading cable-based smart sensor system that is designed to handle some of the harshest and most dynamic conditions. The **SiloPatrol**  system incorporates state-of-the-art sensors, a wide choice of operator interfaces, auxiliary outputs and displays, as well as unique remote/vendor managed inventory solutions.

The introduction of **SiloPatrol** several years ago delivered the first truly robust sensor design, providing reliable and high value solutions for a wide variety of applications and industries worldwide. The second edition **SiloPatrol**  incorporates significant advances in this field-proven approach to reliably monitoring the level of material in bins, silos and tanks up to 150ft (45.7m) in height. The **SiloPatrol**  sensor technology is suitable for use with a multiplicity of powders, granules, slurries and liquids, even in the most harsh and dynamic conditions.

The heart of the **SiloPatrol**  system is the sensor itself. The second edition sensor, Model SMU (Silo Monitoring Unit), incorporates technological advancements (Patent Pending), requires no field adjustments and its robust design provides virtually maintenance-free operation. The SMU is suited for most any application and can be equipped with a variety of mounting flanges and plumb bobs.

The **SiloPatrol**  system also offers the most sensor interface choices:

- RS485 "smart" communications output
- 4-20mA analog output
- AC/DC Pulse output

The "smart" RS485 output version SMU can be connected with either the multi-functional Human Machine Interface (HMI) or with **SiloTrack**™ PC-based Inventory Management Software that provides a flexible graphical interface for up to 128 sensors.



If a stand alone sensor with analog output and no operator interface display is what you are looking for, the SMU is available in this type of configuration at a low purchase price. The second edition SMU is available as a truly standalone analog output transmitter, including automatic measurement initiation and a relay output.

The SMU pulse output sensor is typically used for connecting into older Monitor Technologies inventory systems. This output version retrofits and replaces the older CM3A/CM4 sensors and uses the AC pulse output to connect to the old system console. The DC pulse output also included with the second edition SMU pulse output version can be used to connect into existing PLC systems.

PRINCIPLE OF OPERATION

Once a measurement cycle is initiated, the **SiloPatrol**®  sensor (SMU) “smart” motor system controls the descent of a plumb bob, attached to a heavy-duty stainless steel cable, into the vessel. The SMU measures the amount of cable dispensed via its unique optical sensing system. The SMU’s optic system is completely sealed from the internal environment of the electronics compartment, which is isolated and sealed from material ingress in the mechanical compartment, to ensure long-term reliable operation.

The descent of the bob is maintained at an optimal speed by the “smart” motor control system, contributing to the elimination of cable slack and maximizing the motor life. In conjunction with the unique dual optical sensing system, the “smart” motor control system guarantees that the bob will stop when it contacts the material surface and eliminates the need for a mechanical brake. When the bob reaches the material surface, the SMU reverses the direction of the motor and transmits the distance value.

During the ascent of the bob, the SMU measures the amount of cable gathered and controls the speed of ascent. This ensures proper cable wrapping in the patented storage reel and tangle-free operation.

The second edition SMU also includes a patent pending Hall effect sensor array that monitors the movement and position of the swing-arm that controls the absorption of slack in the cable system during descent and ascent. The second edition SMU is smarter than ever and uses this technology to control the cable and plumb bob travel to ensure reliability of the measurement cycle, even with harsh changing conditions in the most severe applications.

The standalone versions of the SMU generate their respective 4-20mA or Pulse output in response to a measurement query, or automatically with the analog output version. The standard “smart” RS485 SMU communicates with the operator interface chosen for the system (HMI or **SiloTrack**™ PC software). These operator interfaces can perform calculations and conversions to display the data in the format desired. The **SiloPatrol**  system, if so equipped, will also generate auxiliary analog and/or relay outputs. RS485 communications can be accomplished via hardwiring or with wireless transceivers.

APPLICATIONS

The **SiloPatrol**®  Inventory Management System can be used in a wide variety of applications. These include, but are not limited to, simple inventory monitoring with a standalone HMI display to Remote and Vendor managed inventory solutions using **SiloTrack**™ server and client software to manage inventories at multiple facilities while providing access to a virtually unlimited number of users.

Materials being monitored include a broad list of powders and bulk solids, as well as a wide range of liquids and slurries. These include coarse/fine granular solids, powders, liquids, foodstuffs and even some sticky or corrosive substances. The nature of second edition SMU sensor electronics also makes it ideal for environments with temperature extremes and ambient temperature variations.





TYPICAL APPLICATIONS INCLUDE, BUT ARE NOT LIMITED TO:

- | | |
|------------------|-------------------------|
| Feeds | Bulk Chemicals |
| Cement | Plastic Pellets |
| Rocks | Coal |
| Liquids | Sand |
| Limestone | Plastic Re grind |
| Oils | Powders |
| Grains | |

REMOTE INVENTORY MONITORING

If material levels need to be monitored at one or many locations (i.e. your facility, a location down the street, or a plant on the other side of the world) the **SiloPatrol**®  system can provide accurate and reliable measurements. Using **SiloTrack**™ Version 3.5 software, inventory monitoring from remote locations has never been easier.



Remote Managed Inventory Solution

WIRELESS SENSOR COMMUNICATIONS INTERFACE

While using the **SiloPatrol**®  “smart” sensor is the most economical approach available for inventory monitoring, using the available wireless interface in your application may help you reduce the installed cost of your **SiloTrack**™ / **SiloPatrol**®  system even further.



SiloPatrol®  unit shown with wireless interface

The wireless transceivers use frequency-hopping spread-spectrum wireless technology and operate in the FCC license-free 900MHz band. This provides the longest range and most reliable wireless communications available.

Working in conjunction with **SiloTrack**™ PC-Based inventory management software, the wireless transceivers provide the most functional and economical inventory management system available today.

Refer to Bulletin 343D for additional information and contact our technical support personnel today to see if your application can benefit from the a wireless communications solution.



ELECTRONIC FEATURES

- ▼ Industry-exclusive use of magnetic Hall effect sensor technology (patent pending) monitors swing-arm movement and improves overall application reliability and performance, even with the most difficult dynamic conditions

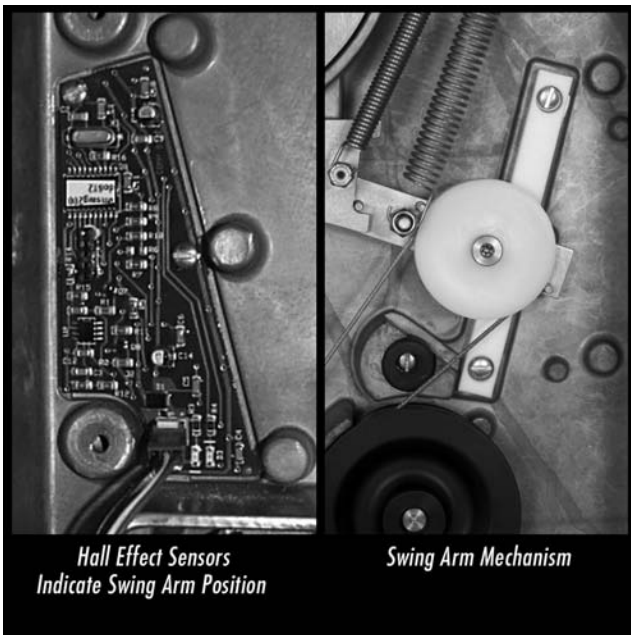

- ▼ Microcontroller technology provides “smart” motor control, high resolution/accuracy and consistent performance under the most challenging and dynamic conditions
- ▼ Lock-out input on all models to restrict sensor from initiating a measurement cycle (used to disable measurement during filling operations)
- ▼ Industry-exclusive electronics certified to international CE 1010 standard ensures compliance in shock hazard protection, electromagnetic noise interference and generation

- ▼ Complete electrical isolation between inputs/outputs and earth ground eliminates ground loops and ensures proper long-term operation and data communication
- ▼ Superior resolution of 0.01ft (0.12”; 3mm)
- ▼ Unique optical measuring system uses an amplification circuit to maximize signal-to-noise performance
- ▼ Relay output standard on analog output version provides contact closure based on user set level, sensor failure or measurement cycle operating

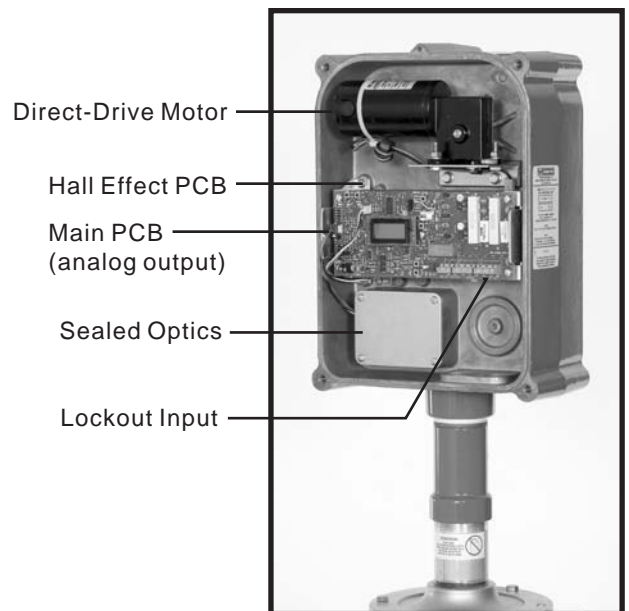

Electronic Compartment

MECHANICAL FEATURES

- ▼ Split-compartment enclosure completely isolates electronics from mechanical section of sensor
- ▼ Industry-exclusive compartment seals optical sensors from internal SMU environment completely eliminating problems created by contamination, even from conduits
- ▼ Industry-first direct-drive motor and heavy-duty cable system deliver unsurpassed pull strength
- ▼ Process seal (wiper seal mechanism) easily replaced without removing or cutting cable



- ▼ Freeze-resistant flange can eliminate problems in applications where changing environmental conditions and condensation are present
- ▼ Patented storage reel incorporates a "step" to ensure non-tangling cable wrap

- ▼ Cable pathway and storage reel are completely captive, eliminating cable-jump
- ▼ Wide variety of plumb bobs available including cast aluminum or SS, standard plumb bob, SS inverted cone, Teflon coated and digestible

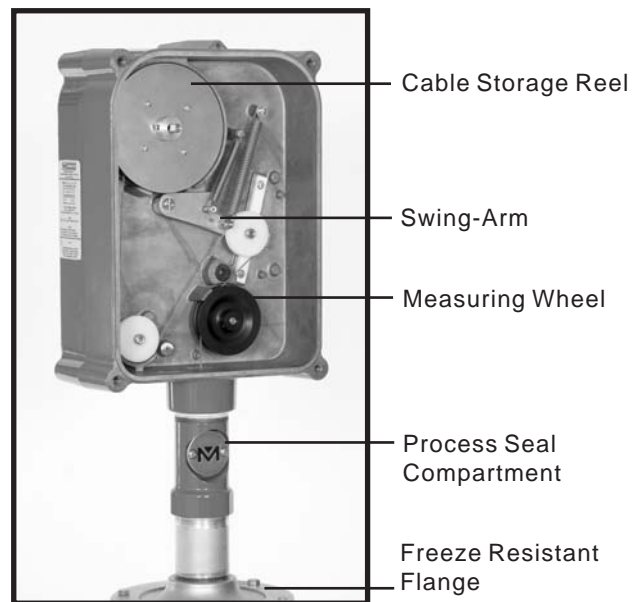

Mechanical Compartment

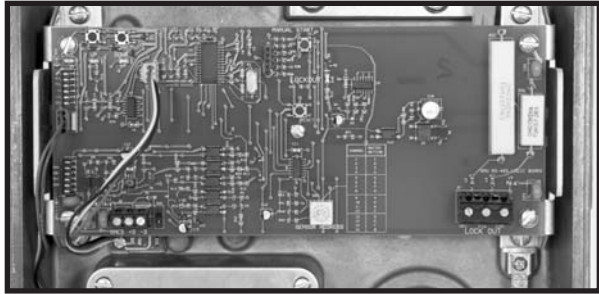

Standard "Smart"

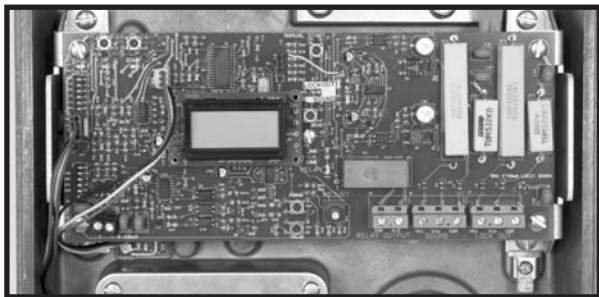

Analog 4-20mA

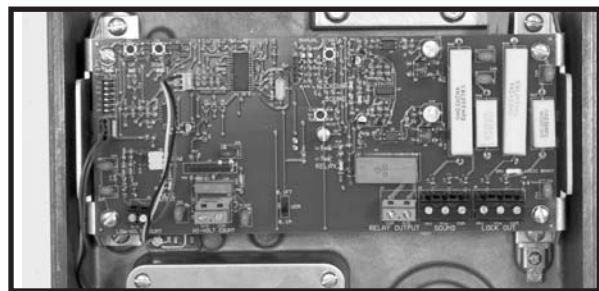

Pulse (retrofit)

SMU MODEL SELECTIONS

OUTPUT TYPES

Standard "Smart" – The SMU communicates with the HMI or **SiloTrack**™ PC-based Inventory Management Software via a RS-485 proprietary protocol. This type of system can also be equipped with auxiliary relay and/or analog outputs and remote displays.

Analog 4-20mA – This SMU sensor is a standalone transmitter version providing a direct analog signal for each measurement update. Measurements are initiated automatically as setup within the sensor or in response to a remotely activated contact closure. This sensor version is provided with a relay output that can be set to activate when a user established level is reached, upon detection of a sensor error or when a measurement cycle is in process.

Pulse (retrofit) – This SMU version generates AC or DC pulses in response to a request for a measurement from a contact input. This output can be used to provide direct input into a PLC or to integrate into an older Monitor Technologies Model CM console when replacing the old Model CM-3A or CM-4 sensors. The SMU provides only a 1/10' or dm pulse output. This sensor version is provided with a relay output that indicates when a measurement cycle is in process.

APPROVALS

The **SiloPatrol**®  Model SMU sensor is available certified for either Ordinary or Hazardous locations. The SMU also carries the CE Mark. Consult the Specifications section for further information.



FREEZE-RESISTANT MOUNTING FLANGES

SMU sensors can be provided with either the standard flat mounting flange or one of the angled flanges (5° and 10° available) for adapting to sloped roofs. Each of these standard flanges has a unique design that resists freezing of the plumb bob to the underside of the flange. This is especially important in very cold climate conditions where moisture from condensation within the silo can form and create ice on the underside of the silo roof, usually due to cycling above and below freezing temperature in an outdoor installation. In these applications the freeze-resistant flange may eliminate the need for standpipe or flange heating. Contact the factory for modified ANSI/DIN flanges (not “freeze resistant”).

SMU ACCESSORIES

PLUMB BOBS

Standard Cast Aluminum – Most SMU sensors are shipped with this plumb bob assembled to the unit. For use with bulk solids with a bulk density greater than 20lbs/ft³ (320kg/m³). A Teflon[®] coated version is also available for sticky materials.

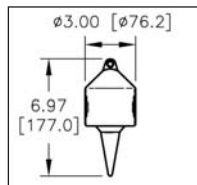

316 Stainless Steel – For use with corrosive solids and foodstuffs with bulk densities greater than 20lbs/ft³ (320kg/m³). This plumb bob is typically shipped as a separate item, but can be assembled to the SMU at the factory upon request.

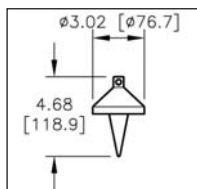

316 SS Inverted Cone – For use with light bulk solids and foodstuffs with bulk densities greater than 5lbs/ft³ (80kg/m³). Teflon[®]-coated also available for corrosive or sticky materials. This is shipped as a separate line item and must be attached to the cable in the field.

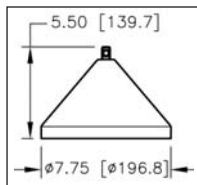

6in. (152mm) Diameter 316 SS Ball Float - For use with liquids with a minimum specific gravity of 0.85. A Teflon[®]-coated version is also available for corrosive or sticky materials. This plumb bob is shipped as a separate line item and must be attached to the cable in the field.

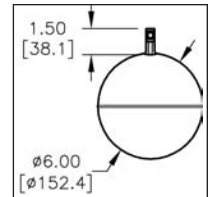

HMI FEATURES

- ▼ Multi-functional HMI controls SMU “smart” output sensor operation, auxiliary output activation (if equipped), displays measured and calculated data and performs/displays system and sensor diagnostic messages
- ▼ Industry-exclusive electronics certified to stringent international CE 1010 standards to ensure worldwide compliance in shock hazard protection, electromagnetic noise interference and generation
- ▼ Unique back-lit display ensures visibility in any environment
- ▼ Environmentally hardened NEMA 4 enclosure with ambient temperature limits down to -4°F/-20°C
- ▼ Automatic, Manual or Auto/Manual operating modes
- ▼ With data input from the user, HMI can calculate and display values for level, volume, weight and percent (See "Use of Volume/Weight Calculations")
- ▼ Flexible display of data in English or Metric units including feet, meters, pounds, kilograms, cubic feet, cubic meters, U.S./British bushels, gallons, liters, tons, metric tonnes
- ▼ Displays 12-character alphanumeric name for vessel contents



HMI OPERATING MODES

MANUAL MODE

The HMI is easily programmed to display calculated level, volume, weight or percent in addition to the basic distance measurement. Manual readings are taken by depressing the MEAS button, followed by the channel number, followed by ENTER.

AUTOMATIC MODE

The HMI can also be programmed to operate the SMU “smart” output sensors automatically. Menu options allow the user to select days of operation (such as Mon.-Fri.), time window (such as 7 a.m.-3 p.m.) and measurement interval (minimum 30 minutes).

HMI MODEL SELECTIONS

APPROVALS

The HMI is designed for Ordinary Locations. The HMI also carries the CE Mark.

NUMBER OF CHANNELS

The HMI is available in 2-, 8- or 16-channel configurations. The individually addressable SMU “smart” output sensors are wired to the HMI using a single RS-485 network cable. Multiple SMU “smart” output sensors (up to a maximum of 16) can be connected to the HMI using a single RS-485 network cable.

PC-BASED INVENTORY MANAGEMENT SOFTWARE

SiloTrack™ Version 3.5 Inventory Management Software provides users with an unsurpassed, flexible graphical interface for **SiloPatrol®** “smart” output sensors. Together, **SiloTrack** Server and Client software can provide inventory monitoring and management to a virtually unlimited number of users, both internal and external to your facility. This allows easy implementation of remote monitoring and vendor managed inventory programs.

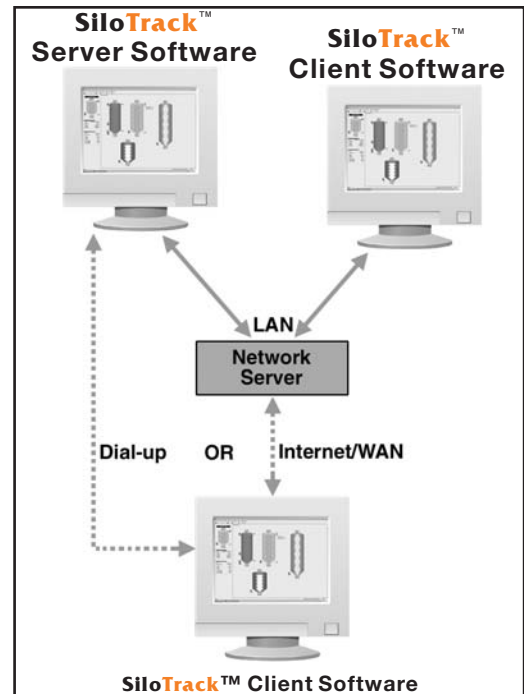

VMI/RMI (Vendor/Remote Managed Inventory)

SiloTrack capabilities include:

- ▼ Monitor up to 128 sensors/with up to 5 sensors per vessel
- ▼ Easy to setup and use
- ▼ Network-ready
- ▼ Remote monitoring via LAN, Internet/WAN or dial-up
- ▼ Available in English/Spanish language
- ▼ Automatic and manual measurement initiation
- ▼ Curve-fit weight table
- ▼ Enhanced 3-D type silo graphics
- ▼ Export silo history and alarm data
- ▼ Automatic Reports and Scheduling
- ▼ Set up four alarms per silo
- ▼ Alarm notification via e-mail, fax, and/or pager

Please refer to Bulletin 343B for additional information.



USE OF VOLUME/WEIGHT CALCULATIONS

The **SiloPatrol**® Σ Model SMU sensor makes a direct measurement of the distance between the sensor and the material surface. This equipment does not measure the volume or weight of the material within the vessel. The HMI and **SiloTrack**™ PC-based software, when used with a **SiloPatrol** Σ "smart" output sensor, may be able to perform calculations to display the volume and weight of the material. These calculations are based upon the distance measurement and the vessel dimensions and material bulk density entered by the user during setup.

Note: The calculated volume and weight values should be considered "estimates". Monitor Technologies LLC accepts no responsibility for the accuracy of the calculated and displayed volume and weight values. The accuracy (not stated or warranted) of the volume/weight calculations are effected by the fluctuation and accuracy of various factors. These factors include, but may not be limited to, actual vessel dimensions, sensor mounting location, angle of repose (negative and positive), material bulk density, material flow properties (ratholes, bridging, etc.), material inlet/discharge locations and material packing. Please consult the factory to discuss applications where volume/weight is of critical importance.

SYSTEM ACCESSORIES

AUXILIARY OUTPUT ENCLOSURES

A unique feature of the **SiloPatrol**® Σ Inventory Management System is the ability to incorporate both relay and analog outputs with a standard "smart" output sensor system. These auxiliary relay and/or analog outputs are provided in Auxiliary Output Enclosures (AOE) and are programmed and controlled by either the HMI or **SiloTrack**™ PC-based Inventory Management Software.

One analog output and up to four relays (two for HMI; four for **SiloTrack**) can be assigned to each of the "smart" output sensors. These can be used to tie the Inventory Management System into remote control systems, sound alarms and for local control functions.

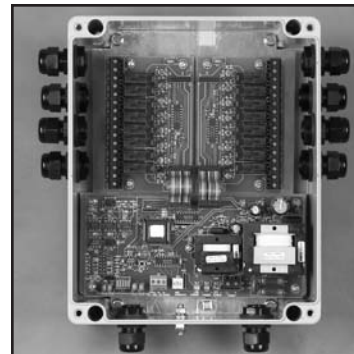

2-Card AOE

Up to 16 analog outputs or 32 relays can be provided within a single enclosure. Up to four AOE's can be connected on a single network. The AOE can be located close to the point of hardwiring termination minimizing wiring and installation costs.

REMOTE DISPLAY UNIT

SiloPatrol® Σ systems using the standard "smart" SMU can be provided with Remote Display Units (RDU). These units have the same display capability as the HMI. They, however, can not be used to initiate any measurements. They are identical to the HMI in specification and appearance. User setup is required in order to view the data in the desired units of measure. A maximum combination of four AOE's and RDU's can be connected on each network.



MECHANICALS

DIMENSIONS ARE SHOWN IN INCHES WITH MILLIMETER EQUIVALENT IN BRACKETS

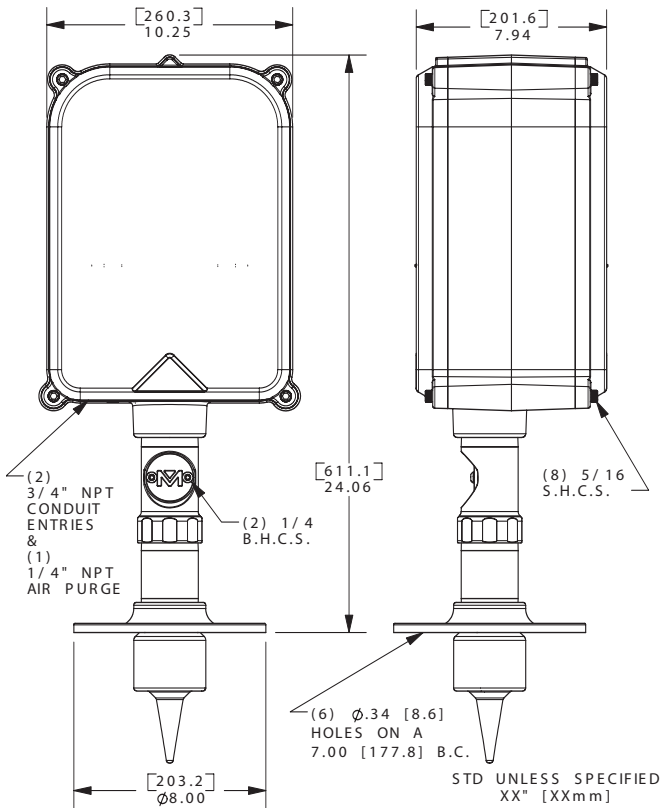

DIMENSIONS ARE SHOWN IN INCHES WITH MILLIMETER EQUIVALENT IN BRACKETS

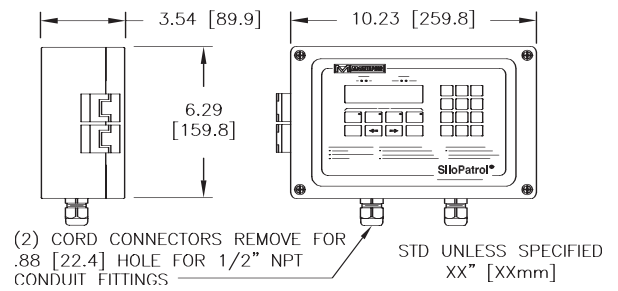

Above:
Human Machine Interface (HMI) Remote Display Unit (RDU)

Left:
Silo Monitoring Unit (SMU)



ORDERING INFORMATION

SILO MONITORING UNIT (SMU)

6 - 85 X X - X X X 2

OUTPUT TYPE

- 1 = Standard "smart" communications
- 2 = Pulse (retro) output
- 3 = 4-20mA analog output

OPERATING VOLTAGE

- 1 = 115 VAC
- 2 = 230 VAC

MOUNTING FLANGES

- 1 = Standard K-flange
- 2 = 5° K-flange
- 3 = 10° K-flange

CABLE TYPES Up to 150 ft. (45.7 m)

- 1 = Nylon jacket
- 2 = Stainless steel
- 3 = Polyethylene jacket

OPTIONAL PLUMB BOBS & ACCESSORIES

6-2190	Digestible Plumb Bob
6-2021	Cast Epoxy Plumb Bob
6-3123	Cast Aluminum with Teflon® Coating
6-3136	316 Stainless Steel
6-4106	316 Stainless Steel Inverted Cone
6-4126	Teflon® -Coated 316 Stainless Steel Inverted Cone
6-4108	316 Stainless Steel Ball Float
6-4128	Teflon® -Coated 316 Stainless Steel Ball Float
6-3125	5° Mounting Flange
6-3128	10° Mounting Flange

ENVIRONMENT

- 1 = Ordinary locations CSA_{US/C}
- 2 = Hazardous locations CSA_{US/C} (North America)
- 3 = Hazardous locations ATEX

Note: 6-3103 cast aluminum plumb bob is included with each SMU.

AUXILIARY OUTPUT ENCLOSURE (AOE)

6 - 88 X X - X X X

Note: The total sum of analog and relay cards can not be greater than the packaging configuration selected

PACKAGING CONFIGURATION

- 2 = 2 card system
- 4 = 4 card system

ENVIRONMENT

- 1 = Ordinary Locations

RELAY CARDS

- 0 = None
- 1 = 1 card (8 relays)
- 2 = 2 cards (16 relays)
- 3 = 3 cards (24 relays)
- 4 = 4 cards (32 relays)

ACCESSORIES

6-5133	Relay Board Kit (For field upgrade)
6-5134	Analog Board Kit (For field upgrade)
6-4011	Wall Mounting Bracket (Set of 4)

OPERATING VOLTAGE

- 1 = 115 VAC
- 2 = 230 VAC

ANALOG CARDS

- 0 = None
- 1 = 1 card (4 4-20mA loops)
- 2 = 2 cards (8 4-20mA loops)
- 3 = 3 cards (12 4-20mA loops)
- 4 = 4 cards (16 4-20mA loops)



HUMAN MACHINE INTERFACE (HMI)

6-8611-21	2-Channel 115VAC
6-8621-21	2-Channel 230VAC
6-8611-81	8-Channel 115VAC
6-8621-81	8-Channel 230VAC
6-8611-61	16-Channel 115VAC
6-8621-61	16-Channel 230VAC

REMOTE DISPLAY UNIT (RDU)

6-8711-61	16-Channel 115VAC
6-8721-61	16-Channel 230VAC

SPECIFICATIONS

Silo Monitoring Unit (SMU)

Power Requirements:	115VAC or 230VAC, 50/60 Hz
Power Consumption:	6VA continuous, 50VA intermittent
Altitude:	6562ft (2000m) maximum
Installation Category:	II
Pollution Degree:	4 (reduced to 2 via enclosure), Suitable for indoor/outdoor use
Process Temperature:	-40° F to 300° F (-40° C to 149° C)
Ambient Operating Temperature:	-40° F to 150° F (-40° C to 65° C)
Maximum Internal Bin Temp:	Up to 300°F (149°C) with use of bare stainless steel cable; Up to 200°F (93°C) with use of stainless steel jacketed cables
Measurement Range:	150 feet maximum (45.7 m)
Measurement Rate:	1.0ft/sec (typical) (0.3 m/s)
Accuracy:	± 0.25% of distance reading
Repeatability:	0.1ft (30 mm)
Resolution:	0.01ft (0.12in/3mm)
Conduit Entry:	(2) 3/4" NPT
Mounting:	Freeze-Resistant "K" flange, 8"dia w/ 7" bolt circle
Cable:	1/16" nylon-jacketed (270lb/123kg tensile strength) 3/64" SS unjacketed (270lb/123kg tensile strength) 1/16" polyethylene-jacketed, (270lb/123kg tensile strength)
Output Signal:	
Standard "Smart":	RS-485 half-duplex, isolated, proprietary protocol
Pulse:	1 pulse per 1/10ft or dm, isolated, dry contact, selectable: 0.1ft - 12Hz, time-on 40mS, time-off 45mS dm - 4Hz, time-on 40mS, time-off 210mS AC Pulse - 70mA max @ 24-250VAC DC Pulse - 70mA max @ 24VDC
Analog:	Relay Output – 5A @ 250VAC max, isolated, dry contact 4-20mA, reversible to 20-4mA, isolated; 500 Ohms maximum loop resistance Relay Output – 5A @ 250VAC max, isolated, dry contact



Input Signal:	Sound (Pulse, Analog)	Vhi – 98-265VAC/VDC, 9.5K ohm input, isolated Vlo – 20-55VAC/VDC, 2.0K ohm input, isolated
	Lockout (All)	Vhi – 98-265VAC/VDC, 9.5K ohm input, isolated Vlo – 20-55VAC/VDC, 2.0K ohm input, isolated
Wiring Distance (“smart”):		4,000ft (1,220m) maximum
Address Determination (“smart”):		1-16 (switch selectable)
Internal Display (Analog):		2 lines, 8 characters per line, LCD
Shipping Weight:		35lbs (15.6kg)
Enclosure:		Cast aluminum w/ powder coat finish
Overall Dimensions:		24.06” x 10.25” x 7.94” (611mm X 260mm X 202mm)(H x W x D)
Plumb Bob Weight:		2 lbs. (0.9 kg)
Air Purge Connection:		1/4” NPT
Enclosure Rating:		NEMA 4X, IP66
Approvals:	Ordinary Location:	CSA _{US/C} , CE Mark
	Hazardous Location:	CSA _{US/C} Class II, Div. 1 & 2, Groups E, F & G ATEX [®] II 1/2 D T 75°C

Teflon[®] is a registered trademark of Dupont Chemical Co.

Human Machine Interface (HMI)

Power Requirements:	115VAC or 230VAC, 50/60Hz
Power Consumption:	10VA max
Ambient Operating Temperature:	-4° F to 131° F (-20° C to 55° C)
Sensor Communication:	RS-485 half-duplex, non-isolated, proprietary protocol
Channels:	2, 8 or 16
Display:	2 lines, 20 characters per line, 0.22” x 0.12” characters, LCD backlight
Keypad:	20 keys
Indicators:	8 LEDs (function, relay, and error status)
Enclosure	Painted Aluminum
Overall Dimensions:	6.29” x 10.23” x 3.54” (160mm X 260mm X 90mm)(H x W x D)
Enclosure Rating:	NEMA 4, IP66
Approvals:	CE Mark

Auxiliary Output Enclosure (AOE)

Power Requirements:	115VAC or 230VAC, 50/60 Hz
Power Consumption:	25VA Max
Ambient Operating Temperature:	-4° F to 131° F (-20° C to 55° C)
Communication:	RS-485 half-duplex, isolated, proprietary protocol
Analog Outputs:	4-20mA, 16 max, 4 per card, non-isolated, 500 ohm max loop resistance, 10 bit resolution, zero/span set via HMI/ SiloTrack [™]
Relay Outputs:	SPST, 5A @ 250 VAC, 32 max, 8 per card, visual LED per relay, assignment and action set via HMI/ SiloTrack [™]
Enclosure:	Painted Aluminum



Overall Dimensions: (H x W x D)
2-Card: 11.02" x 9.05" x 4.33" (280mm X 230mm X 110mm)
4-Card: 15.74" x 9.05" x 4.33" (400mm X 230mm X 110mm)
Enclosure Rating: NEMA 4, IP66
Approvals: CE Mark

Remote Display Unit (RDU)

Power Requirements: 115VAC or 230VAC, 50/60Hz
Power Consumption: 10VA max
Ambient Operating Temperature: -4° F to 131° F (-20° C to 55° C)
Sensor Communication: RS-485 half-duplex, non-isolated, proprietary protocol
Channels: 16
Display: 2 lines, 20 characters per line, 0.22" x 0.12" characters, LCD backlight
Keypad: 20 keys
Indicators: 8 LEDs (function, relay, and error status)
Enclosure: Painted Aluminum
Overall Dimensions: 6.29" x 10.23" x 3.54" (160mm X 260mm X 90mm)(H x W x D)
Enclosure Rating: NEMA 4, IP66
Approvals: CE Mark

WARRANTY

Monitor Technologies LLC warrants each **SiloPatrol**®  Inventory Management System it manufactures to be free from defects in material and workmanship under normal use and service for two (2) years from the date of purchase. The purchaser must notify Monitor of any defects within the warranty period, return the product intact, and prepay transportation charges. The obligation of Monitor Technologies LLC under this warranty is limited to repair or replacement at its factory. This warranty does not apply to any product which is repaired or altered outside of Monitor Technologies' factory, or which has been subject to misuse, negligence, accident, incorrect wiring by others, or improper installation. Monitor Technologies LLC reserves the right to change the design and/or specifications without prior notice.





Huntsman, Inc. ▼ 2362 Warren Ave. ▼ Twin Falls, Idaho 83301 ▼ (877) 733-2214 ▼ (208) 733-2214 ▼ Fax (208) 733-2240
www.huntsmaninc.com ▼ mail@huntsmaninc.com

